

STEP #9 - INSTALL DOOR GUIDES

- INSTALL HEADSTOPS AS SHOWN IN DIAGRAM 20 ON EACH GUIDE USING THE 5/16" - 18 x 1" BOLTS (28), 5/16" LOCK WASHERS (30), 5/16" FLAT WASHERS (31) AND 5/16" - 18 NUTS (29) PROVIDED.
- THE HEAD STOPS ON THE GUIDES SHOULD BE NO MORE THAN 1" HIGHER (TO BOTTOM OF STOPS) THAN THE DOOR HEADER. IF NOT, CUT THE BOTTOM OF THE GUIDES TO MATCH YOUR OPENING HEIGHT AND RELOCATE SLIDE BOLT NOTCH AT BOTTOM OF THE GUIDE.
- RAISE THE DOOR CURTAIN SO THE BOTTOM ANGLE IS APPROXIMATELY 3" / 76.2mm BELOW THE HEADER. SLIDE THE GUIDE OVER THE DOOR CURTAIN AND POSITION AGAINST THE DOOR OPENING ALLOWING 3/8" / 9.5mm CLEARANCE FROM THE EDGE OF THE CURTAIN TO INSIDE THE GUIDE.
- INSTALL THE FASTENERS, LOWER CURTAIN INTO GUIDES SLOWLY, MAINTAINING PROPER CLEARANCE AND STOP 6" / 152.4mm ABOVE THE FLOOR. INSTALL BOTTOM FASTENERS. CHECK IF THE GUIDES ARE PLUMB USING A LEVEL. THE FASTENERS SHOULD BE LOCATED APPROXIMATELY EVERY 24" / 609.6mm STARTING 6" / 152.4mm FROM THE FINISHED FLOOR, INSTALL BALANCE OF FASTENERS AND BEND THE LEAD-IN AT THE TOP OF THE GUIDE TO 45-DEGREE ANGLE.
- FOR "WINDLOAD CERTIFIED DOORS" REFER TO SHOP DRAWINGS FOR FASTENER/ANCHOR TYPE FREQUENCY.
- SPRAY SILICONE LUBRICANT IN THE GUIDES FOR EASE OF OPERATION.

DIAGRAM 20

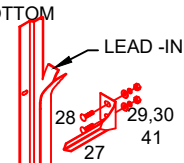

NOTE:

- DOORS ORDERED FOR CONCRETE/MASONRY APPLICATIONS WILL INCLUDE 1/4"x1-3/4" TAPCONS (84) FOR GUIDE INSTALLATION. BLOCK CLIPS WELDED TO THE BACK OF GUIDE FOR CONCRETE/MASONRY APPLICATION ARE OPTIONAL.

STEP #10 - CHECK AND ADJUST BALANCE

IF DOOR LOWERS EASILY AND RAISES HARD, MORE TENSION IS REQUIRED. IF THE DOOR LOWERS HARD AND RAISES EASILY, LESS TENSION IS REQUIRED. (SEE DIAGRAM 18)

CAUTION: FOR ALL DOOR DRIVES: BEFORE ADJUSTING THE SPRINGS, PULL THE DOORS INTO THE UP POSITION. SECURE THE DOOR BY THE FOLLOWING METHODS:

- TIE ROPE AROUND THE DOOR ROLL.
- PLACE A CLAMP AT THE TOP OF THE GUIDE CHANNEL TO SECURE THE CURTAIN IN THE GUIDES.

WARNING: WHEN AXLE CLAMPS ARE LOOSE, THE SPRINGS WILL BE VERY STRONG. YOU WILL NEED TWO PEOPLE TO ADJUST THE DOOR TENSION SAFELY.

- EACH PERSON SHOULD FIRMLY PLACE A LARGE PIPE WRENCH ON THE AXLE (SEE DIAGRAM 18). LOOSEN THE AXLE CLAMPS AND PULL DOWN FOR MORE TENSION AND UP FOR LESS TENSION. FOR POCKET WHEEL REDUCTION DRIVE DOORS, REMEMBER TO LOOSEN SET SCREWS PRIOR TO ADJUSTMENT AND RETIGHTEN SECURELY AFTER ADJUSTMENT.
- RETIGHTEN THE AXLE CLAMP HARDWARE
- REPEAT ABOVE STEPS IF FURTHER ADJUSTMENT IS NECESSARY. BEGIN AT STEP 6B.

STEP #11 - INSTALL TOP DRAFT STOP

- PULL DOOR DOWN AND LOCK. GO OUTSIDE AND MARK A LINE ON THE DOOR CURTAIN AT CENTER OF FULL SLAT ABOVE THE HEADER AS SHOWN, (SEE DIAGRAM 21).
- RAISE DOOR 2'-6" / 762mm FROM FLOOR, OR UNTIL MARK IS ACCESSIBLE. PLACE TOP DRAFT STOP IN POSITION AS SHOWN AND SECURE WITH TEK SCREWS. STRETCH RUBBER SLIGHTLY AND SECURE OTHER END. LOCATE AND INSTALL THE REMAINDER OF TEK SCREWS AT 12" / 304.8mm O.C.

DIAGRAM 21

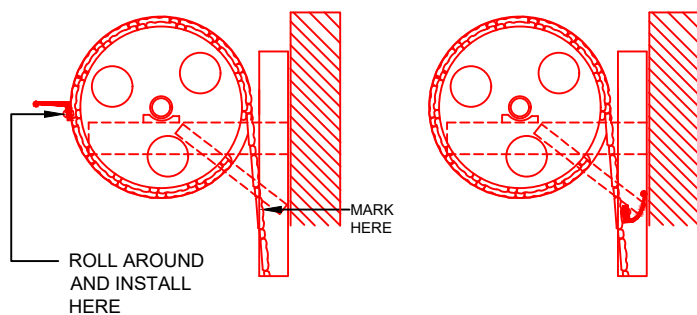

STEP #12 - INSTALL JAMB BRUSH SEAL

DIAGRAM 22

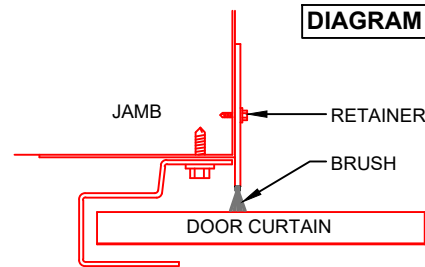

- INSERT BRUSH INTO RETAINER. LINE UP RETAINERS ALONG JAMB SO THAT BRUSH SEAL FILLS THE DOOR CORRUGATION WHEN DOOR IS IN THE CLOSED POSITION. ATTACH RETAINER TO JAMB USING APPROPRIATE FASTENERS AT 6" / 152.4mm FROM FLOOR AND HEADER AND 24" / 609.6mm CENTER MINIMUM.

SERVICE AND MAINTENANCE HINTS

- DOOR CURTAIN DRAGS IN GUIDES:**
 - CHECK DOOR SUPPORT BRACKETS FOR PLUMB.
 - ADJUST LOCATION OF GUIDES FOR 3/8" / 9.5mm - 1/4" / 6.3mm SIDE CLEARANCE, TOP AND BOTTOM.
 - DOOR DRUM ASSEMBLY MAY BE SET TOO CLOSE OR TOO FAR FROM WALL. NOTE: SLOTTED BRACKETS FOR ADJUSTMENT.
 - CHECK GUIDES FOR FOREIGN MATTER, SUCH AS DIRT, ETC.
 - CHECK FOR DAMAGED GUIDES
 - ADJUST LEAD-IN BEND AT TOP INSIDE OF GUIDES
- DOOR OPERATES HARD IN ONE DIRECTION:**
 - CHECK ALL THE ABOVE POINTS.
 - RECHECK STEP NO. 10.
- CHAIN JUMPS OFF CHAIN GEAR:**
 - CHAIN GUIDE COULD BE BENT OUT OF ALIGNMENT WITH CHAIN WHEEL. CHECK FOR DEFECTS IN CAST CHAIN WHEEL OR CHAIN.
 - ON ELECTRIC OPERATOR DOORS OR "POCKET WHEEL" REDUCTION GEAR DOORS, CHECK FOR SPROCKET ALIGNMENT AND PROPER CHAIN TENSION. ALSO CHECK THAT SET SCREWS ON THE POCKET WHEEL ASSEMBLY ARE SECURELY FASTENED.
- DOOR DOES NOT CONTACT FLOOR LEVEL:**
 - USE SPIRIT LEVEL TO CHECK WHETHER DOOR OR FLOOR IS OFF LEVEL. IF DOOR IS OUT OF LEVEL, PROCEED TO CHECK THE FOLLOWING POINTS.
 - POINTS.
 - CHECK IF "SUPPORT BRACKETS" AND GUIDES ARE LEVEL. IF "A" AND "B" CHECK OUT, ROLL DOOR ALL THE WAY UP AND DOWN. SEE IF CURTAIN ROLLS UP STRAIGHT ON TO DRUMS. END OF DOOR SHOULD BE SQUARE. IF CONE SHAPED, GO TO SEC. 5.
- DOOR DOES NOT ROLL UP STRAIGHT:**
 - CHECK ALL POINTS IN SEC. 1
 - AN ALTERNATIVE SOLUTION TO CORRECT THE CONING DOOR IS TO RAISE CURTAIN UP TO THE STOPS AND DETERMINE WHICH SIDE OF THE BOTTOM ANGLE TOUCHES THE STOPS FIRST.
 - SECURE HAND CHAIN, REMOVE GUIDES, LOWER CURTAIN DOWN TO FLOOR LEVEL. INSTALL A DRUM WEDGE ON SIDE OF THE DOOR FROM WHICH THE BOTTOM ANGLE TOUCHES FIRST. PROCEED TO STEP 0 TO REINSTALL THE DOOR GUIDES. IF PROBLEM PERSISTS, CONTACT FACTORY.

INSTALLATION INSTRUCTIONS

300 SERIES COMMERCIAL SLAT DOORS

USE ASTA AMERICA PARTS ONLY - ALL OTHERS SHALL VOID WARRANTY

WARNING

MOVING DOOR CAN CAUSE SERIOUS INJURY OR DEATH
KEEP CLEAR OF OPENING WHILE DOOR IS MOVING.



SAFETY INSTRUCTIONS

- DO NOT STAND OR WALK UNDER MOVING DOOR. KEEP DOOR IN FULL VIEW AND FREE OF OBSTRUCTION WHILE OPERATING.
 - DO NOT ALLOW CHILDREN TO OPERATE THE DOOR OR AUTOMATIC OPERATOR.
 - REPAIRS OR ADJUSTMENTS SHOULD BE MADE BY A TRAINED SERVICE PERSON USING PROPER TOOLS AND INSTRUCTIONS.
 - TO AVOID INJURY, DO NOT PUT FINGERS BETWEEN DOOR AND GUIDES.
 - READ OWNER'S MANUAL FOR YOUR DOOR AND OPERATOR FOR MORE INFORMATION.
- CAUTION:** USE CORRECT LIFTING PROCEDURES AND EQUIPMENT DURING INSTALLATION OF THIS PRODUCT TO AVOID INJURY OR DAMAGE.

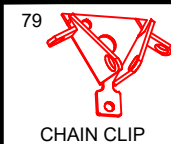

79

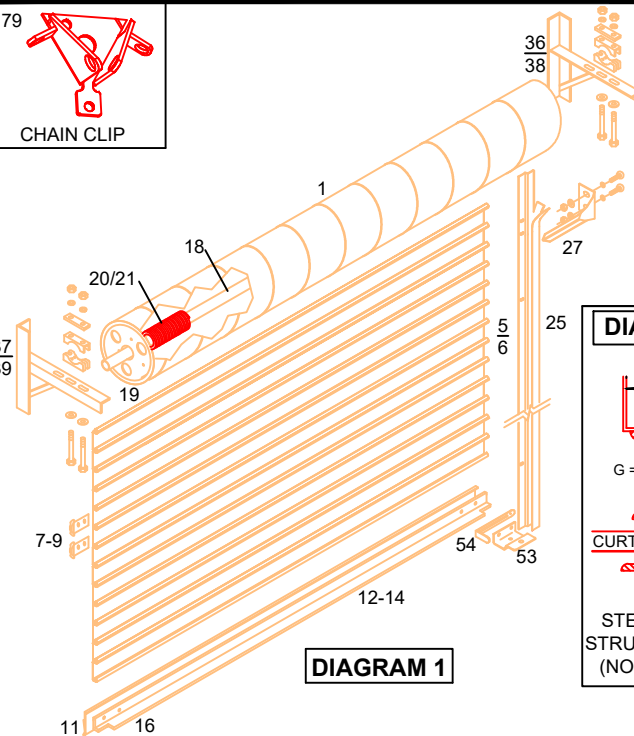

DIAGRAM 1

DIAGRAM 2

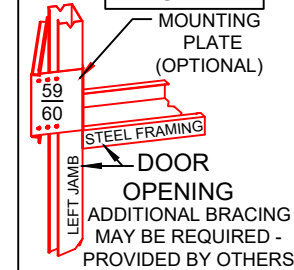

DIAGRAM 3

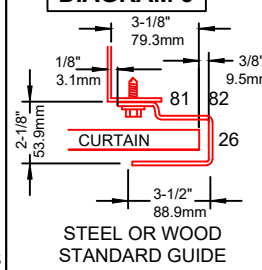

DIAGRAM 4

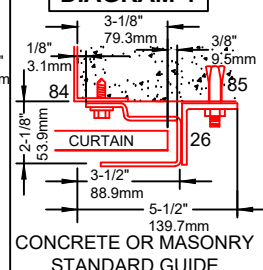

DIAGRAM 5

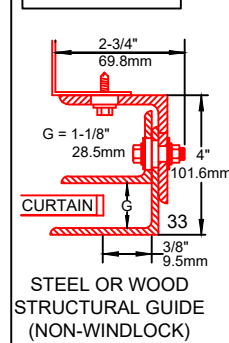

DIAGRAM 6

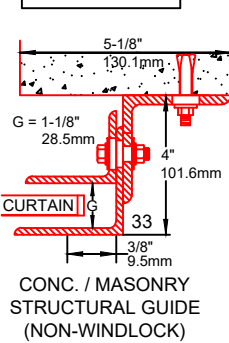

DIAGRAM 7

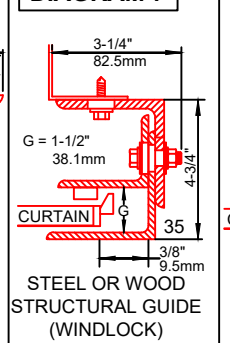
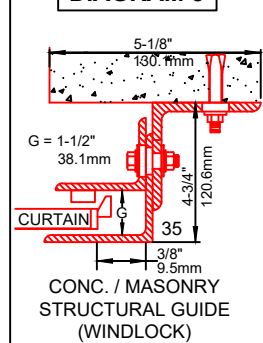

DIAGRAM 8



PARTS LIST

1	VARIABLES	SPIRAL TUBE	33	VARIABLES	DOOR GUIDE, 3 PIECE STRUCT. STEEL - RH	64	420104-1	8:1 POCKET WHEEL CHAIN HOIST ASSEMBLY:
2	VARIABLES	SPIRAL TUBE ATTACHMENT TOPSHEET	34	VARIABLES	WINDLOCK GUIDE, 3 PIECE STRUCT. STEEL-LH	65	440001-1	DRIVE SPROCKET, 41A72-9"
3	VARIABLES	STARTER SLAT-TOP	35	VARIABLES	WINDLOCK GUIDE, 3 PIECE STRUCT. STEEL-RH	66	460700-1	ROLLER CHAIN, #41 x 3.2" (INCLUDED)
4	730708-1	SCREW, #8x1/2" PHILLIPS WAFER K-LATHE TEX	36	310200-1	STANDARD SUPPORT BRACKET, RH	67	440007-1	ELECTRIC OPERATOR (EO) KIT-NOT INSTALLED:
5	VARIABLES	FLAT SLAT PROFILE	37	310300-1	STANDARD SUPPORT BRACKET, LH	68	440001-1	DRIVE SPROCKET, 41A72-9"
6	VARIABLES	CURVED SLAT PROFILE	38	310200-1HD	HEAVY DUTY SUPPORT BRACKET, RH	69	420114-1	2000R-40 CHAIN HOIST ASSEMBLY:
7	450143-1	ENDLOCK - NYLON	39	310300-1HD	HEAVY DUTY SUPPORT BRACKET, LH	70	420105-1	DRIVE SPROCKET, 41A40-3"
8	450144-1	ENDLOCK - CAST IRON	40	310500-1	EXTENDED STANDARD SUPPORT BRACKET, RH	71	420111-1	ROLLER CHAIN, #41 x 3.9"
9	451141-1	WINDLOCK - CAST IRON	41	310510-1	EXTENDED STANDARD SUPPORT BRACKET, LH	72	420114-2	2000R-72 CHAIN HOIST ASSEMBLY:
10	VARIABLES	BOTTOM BAR SUB-ASSEMBLY	42	310500-1HD	EXTENDED HVY. DUTY SUPPORT BRACKET, RH	73	440001-1	DRIVE SPROCKET, 41A72-9"
11	VARIABLES	BOTTOM SLAT	43	310510-1HD	EXTENDED HVY. DUTY SUPPORT BRACKET, LH	74	460698-1	ROLLER CHAIN, #41 x 4.6"
12	190001-1	BOTTOM ANGLE, 2"x1-1/2"x12 GA GALV. STL	44	310103-1	AXLE CLAMP	75	ALL CHAIN HOIST INCLUDE ITEMS BELOW / EO KIT - FASTENERS ONLY:	
13	270008-1	BOTTOM ANGLE 2"x2"x1/8" STRUC. STEEL	45	310102-1	STANDARD KEEPER PLATE - 2 HOLE	76	420107-1	MASTER LINK, #41 (INCL. w/ ALL CHAIN HOIST)
14	270007-1	BOTTOM ANGLE 2"x2"x3/16" STRUC. STEEL	46	730103-1	BOLT, 3/8" - 24 x 3-1/2" HEX HEAD	77	750203-1	LOCK WASHER, 3/8" (INCL. w/ ALL CHAIN HOIST)
15	VARIABLES	ALUMINUM RETAINER	47	740104-1	NUT, 3/8" - 24 HEX HEAD	78	730100-1	HEX HEAD BOLT, 3/8" - 16 1 1/2" (INCL. w/ ALL CHAIN HOIST)
16	260004-F	BOTTOM BULB ASTRAGAL	48	750103-1	WASHER, 3/8" FLAT	79	420300-2	HAND CHAIN RETAINER CLIP (INCL. w/ ALL CHAIN HOIST)
17	VARIABLES	AXLE SUB-ASSEMBLY	49	750203-1	WASHER, 3/8" LOCK	80	420299-1	HAND CHAIN - OPEN LINK (INCL. w/ ALL CHAIN HOIST)
18	VARIABLES	AXLE PIPE	50	420101-1	EXTENDED KEEPER PLATE - 4 HOLE	STANDARD FASTENERS (12 GA HEAVY DUTY GUIDES):		
19	220300BB-1	12" BEARING DRUM ASSEMBLY	51	770301-1	U-BOLT, 3/8" - 16	STEEL JAMBS:		
20	VARIABLES	SPRING - LH	52	740103-1	NUT, 3/8" - 16 HEX HEAD	81	730702-1	TEK SCREW, #14 x 3/4" (GUIDE)
21	VARIABLES	SPRING - RH	53	280301-1	LIFT CLIP - DOOR STOP	WOOD JAMBS:		
22	230001-1	SPRING CLAMP ASSEMBLY	54	280104-1	SLIDE BOLT LOCK	82	730403-1	WOOD LAG SCREW, 1/4" x 2" (GUIDE)
23	740301-1	NUT, 3/8" - 16 SQUARE	55	730301-1	BOLT, 1/4" - 20 x 1 1/4" CARRIAGE	83	730402-1	WOOD LAG SCREW, 3/8" x 2" (BRACKET)
24	730501-1	BOLT, 3/8" - 16 x 1-1/2" SQUARE HEAD SET	56	740201-1	NUT, 1/4" - 20 SELF LOCKING	MASONRY JAMBS:		
25	VARIABLES	DOOR GUIDE, 12GA GALV. HVY. DUTY - LH	57	740102-1	NUT, 5/16" - 18 HEX	84	760203-1	TAPCON SCREW, 1/4" x 1 3/4" (GUIDE-NO CLIPS)
26	VARIABLES	DOOR GUIDE, 12GA GALV. HVY. DUTY - RH	58	750101-1	WASHER, 1/4" FLAT	85	760102-1	SLEEVE ANCHOR, 1/4"x2 1/4" (GUIDE & BRACKET)
27	321105-0	REMOVABLE HEADSTOPS - PAIR	59	310400-1	MOUNTING PLATES, 3/16" STANDARD - PAIR			
28	740206-1	FLAT HEAD PHILLIPS BOLT, 5/16" - 18 x 1"	60	310410-1	MOUNTING PLATES, 1/4" HEAVY DUTY - PAIR			
29	740102-1	HEX NUT, 5/16" - 18	61	420103-1	4:1 POCKET WHEEL CHAIN HOIST ASSEMBLY:			
30	750202-1	LOCK WASHER, 5/16"	62	420105-1	DRIVE SPROCKET, 41A40-3"			
31	750102-1	FLAT WASHER, 5/16"	63	460699-1	ROLLER CHAIN, #41 x 1.9'			
32	VARIABLES	DOOR GUIDE, 3 PIECE STRUCT. STEEL - LH						

STEP #1 - PREPARATION

- CHECK THE HEIGHT AND WIDTH OF THE DOOR OPENING. CHECK IF THE DOOR JAMBS ARE PLUMB.
- CHECK IF THE FLOOR AND HEADER ARE LEVEL.
- CHECK THE DIMENSION PANEL FOR SIDE ROOM AND HEAD ROOM REQUIREMENTS. (SEE DIAGRAM 9)

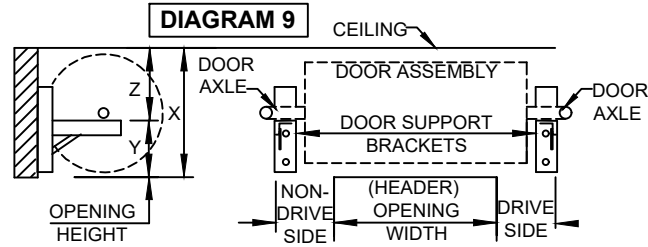

CLEARANCE REQUIREMENTS HEADROOM

HEIGHT	X	Y	Z
UP TO 8' / 2.4m	20" / 508mm	9-1/2" / 241.3mm	10-1/2" / 266.7mm
UP TO 10' / 3.04m	21" / 533.4mm	10" / 254.0mm	11" / 279.4mm
UP TO 16'	23" / 584.2mm	11" / 279.4mm	12" / 304.8mm

NOTE: "Z" DIMENSION INCLUDES 2" TO ALLOW THE BOTTOM ANGLE TO PASS WHEN SPINNING THE DOOR TO PRETENSION THE SPRINGS. IF HEADROOM IS LIMITED YOU CAN DEDUCT 2" FROM "Z" AND TENSION SPRING USING A PIPE WRENCH.

NOTE: RIGHT HAND DRIVE SHOWN, LEFT HAND OPPOSITE.

MODEL (ALL)	DRIVE SIDE	NON-DRIVE SIDE
PUSH-UP / ROPE	7" / 177.8mm	7" / 177.8mm
4:1 OR 8:1 POCKET WHEEL HOIST	8" / 203.2mm	7" / 177.8mm
2000R-40 OR 72 CHAIN HOIST	7-1/2" / 190.5mm	7" / 177.8mm
ELECTRICAL OPERATOR	7-1/2" / 190.5mm	7" / 177.8mm

NOTE: ABOVE DIMENSIONS APPLY TO 12 GA HD GUIDES ONLY.

	PER SIDE
BACK OF GUIDE	3-1/2" / 88.9mm
END OF AXLE	11" / 279.4mm

STEP #2 - INSTALL SUPPORT BRACKETS

- MARK THE HORIZONTAL ANGLE POSITION OF THE SUPPORT BRACKETS.
- MARK THE VERTICAL DIMENSION OF THE SUPPORT BRACKET (DIMENSION "Y") BY USING A TRANSIT OR WATER LEVEL. **THE DOOR MUST BE LEVEL.**
- VERIFY THE MINIMUM HEADROOM REQUIREMENT, DIMENSION "X." IF INSUFFICIENT, LOWER THE BRACKETS UNTIL "Z" IS OBTAINED. IF THE BRACKET IS LOWERED BY MORE THAN 2" / 50.8mm THIS WILL REDUCE THE OPENING HEIGHT. THE GUIDE HEIGHT SHOULD BE REDUCED ACCORDINGLY.
- DRILL HOLES AND FASTEN THE BRACKETS WITH THE PROPER WALL FASTENERS REQUIRED TO OBTAIN A SOLID MOUNTING. USE THROUGH BOLTS ON SOFT BLOCK OR BRICK.

STEP #3 - DRIVE INSTALLATION

- INSTALL THE 4:1 POCKET WHEEL REDUCTION GEAR CHAIN HOIST (IF EQUIPPED) AS FOLLOWS:**

- INSTALL DRIVE SPROCKET (62) ON PREFERRED SIDE USING 3/8"x1-1/2" HEX BOLT. (78) AND 3/8" LOCK WASHER (77).
- SLIDE POCKET WHEEL ASSEMBLY (61) ONTO DOOR AXLE AND ALIGN SPROCKETS PARALLEL TO EACH OTHER.
- CONNECT CHAIN DRIVE (63) AROUND BOTH SPROCKETS USING THE MASTER LINK (76) PROVIDED.
- AFTER THE DOOR TENSION HAS BEEN ADJUSTED (STEP 6), TIGHTEN SET SCREWS ON POCKET WHEEL ASSEMBLY.

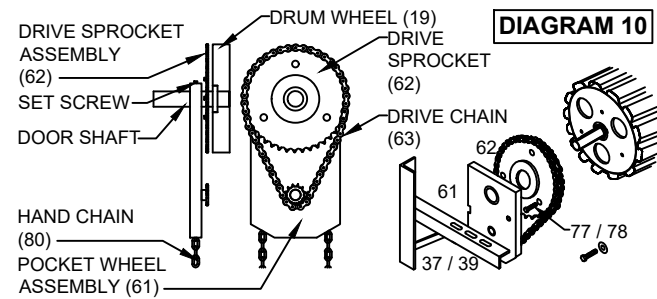

- INSTALL THE 8:1 POCKET WHEEL REDUCTION GEAR CHAIN HOIST (IF EQUIPPED) AS FOLLOWS:**

- INSTALL DRIVE SPROCKET (65) ON PREFERRED SIDE USING 3/8" -16 x1-1/2" HEX BOLT (78) AND 3/8" LOCK WASHER (77) PROVIDED.
- SLIDE POCKET WHEEL ASSEMBLY (64) ONTO DOOR AXLE AND ALIGN SPROCKETS PARALLEL TO EACH OTHER.
- CONNECT CHAIN DRIVE (66) AROUND BOTH SPROCKETS USING THE MASTER LINK (76) PROVIDED.
- AFTER THE DOOR TENSION HAS BEEN ADJUSTED (STEP 6), TIGHTEN SET SCREWS ON POCKET WHEEL ASSEMBLY.

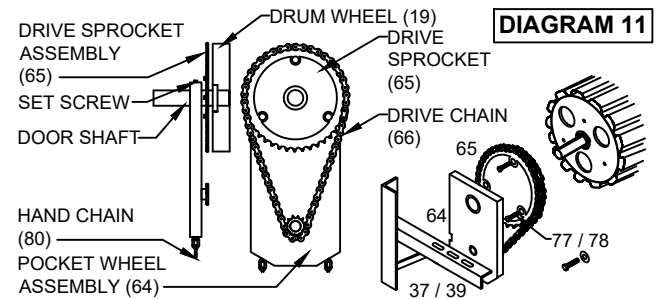

- INSTALL ELECTRIC OPERATOR KIT (IF EQUIPPED) AS FOLLOWS:**

- INSTALL E.O. SPROCKET (68) TO THE END DRUM OF DOOR ON PREFERRED SIDE USING 3/8"x1-1/2" HEX BOLT (78) AND 3/8" LOCK WASHER (77) PROVIDED.

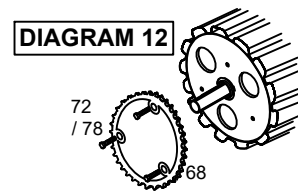

- INSTALL 2000R-72 OR 40 REDUCTION GEAR CHAIN HOIST (IF EQUIPPED) AS FOLLOWS:**

- INSTALL DRIVE SPROCKET ON CORRECT SIDE FOR EXTENDED BRACKET USING 3/8" -16x1-1/2" HEX BOLT (78), 3/8" LOCK WASHER (77).
- INSTALL CHAIN HOIST ASSEMBLY ON TO THE HOIST SUPPORT ANGLES USING 3/8"-16x1-1/2" HEX BOLT (68), 3/8" LOCK WASHER (77), 3/8" FLAT WASHER (48) AND 3/8"-16 HEX NUTS (52) AS SHOWN. (SEE DIAGRAM 13)
- ALIGN BOTH SPROCKETS PARALLEL WITH EACH OTHER.
- CONNECT DRIVE CHAIN (71/74) AROUND BOTH SPROCKETS USING MASTER LINK (76) PROVIDED.

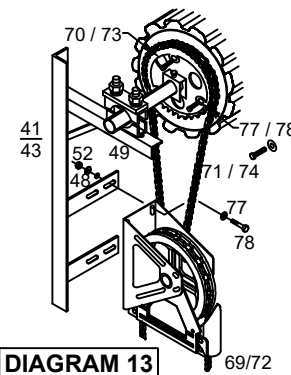

STEP #4 - POSITION DOOR ASSEMBLY

- PLACE THE AXLE CLAMP (44) ONTO DOOR SUPPORT BRACKET. LIFT THE DOOR ASSEMBLY UP ONTO THE SUPPORT BRACKET. (SEE DIAGRAM 14).

NOTE:

- POSITION THE DOOR AS CLOSE TO THE HEADER AS POSSIBLE. ALLOW ROOM TO SPIN THE DOOR. DO NOT ALLOW THE DOOR CURTAIN TO SCRAPE THE HEADER.
- DO NOT USE FORKLIFTS OR GENIE LIFTS WITH UNPROTECTED ARMS/FORKS. THIS CAN CAUSE IRREPARABLE DAMAGE TO DOOR CURTAIN.**

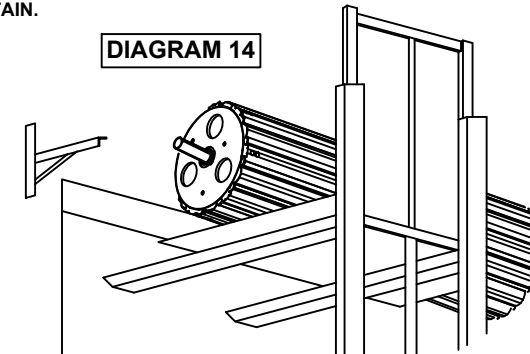

STEP #5 - INSTALL AXLE HARDWARE

- MANUAL PUSH-UP/ROPE DRIVE:**

- PLACE THE AXLE CLAMP (44) ONTO HORIZONTAL MEMBER OF THE SUPPORT BRACKET (36-43) AND UNDER THE DOOR AXLE.
- PLACE AXLE CLAMP (44) AND STANDARD KEEPER PLATE (45) ON TOP OF THE DOOR AXLE AS SHOWN.
- FASTEN AXLE CLAMPS AND STANDARD KEEPER PLATE TOGETHER USING 3/8"x3-1/2" HEX BOLTS (46), 3/8" LOCK WASHERS (49), 3/8" FLAT WASHERS (48), AND 3/8" NUTS (FINE THREAD) (47)---TIGHTEN SECURELY.

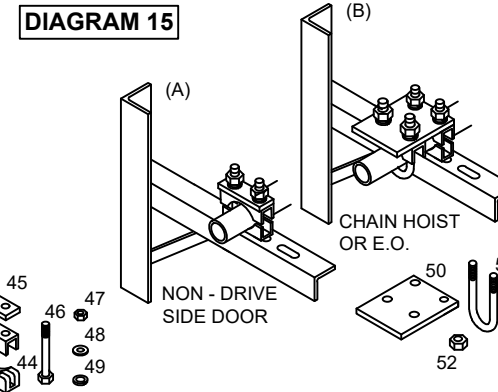

- DRIVE SIDE FOR POCKET WHEEL REDUCTION DRIVE CHAIN HOIST AND E.O. KITS:**

- PLACE THE AXLE CLAMP (44) ONTO HORIZONTAL MEMBER OF THE SUPPORT BRACKET (36-43) AND UNDER THE DOOR AXLE.
- PLACE AXLE CLAMP (44) AND STANDARD KEEPER PLATE (45) ON TOP OF THE DOOR AXLE AS SHOWN.
- FASTEN AXLE CLAMPS AND STANDARD KEEPER PLATE TOGETHER USING 3/8"x3-1/2" HEX BOLTS (46), 3/8" LOCK WASHERS (49), 3/8" FLAT WASHERS (48), AND 3/8" NUTS (FINE THREAD) (47)---TIGHTEN SECURELY.

NOTE:

- REQUIRES A MINIMUM OF 40 ft-lb / 54.23 Nm TORQUE TO PROPERLY SECURE HARDWARE
 - EXTENDED KEEPER PLATE ONLY FOR DOORS SIZES 16' / 4.8m x16' / 4.8m & LARGER.
- NON-DRIVE SIDE FOR POCKET WHEEL REDUCTION DRIVE CHAIN HOIST AND E.O. KITS:**
- PLACE THE AXLE CLAMP (44) ONTO HORIZONTAL MEMBER OF THE SUPPORT BRACKET (36-43) AND UNDER THE DOOR AXLE.
 - PLACE AXLE CLAMP (44) AND EXTENDED KEEPER PLATE (50) ON TOP OF THE DOOR AXLE AS SHOWN.
 - FASTEN AXLE CLAMPS USING 3/8"x3-1/2" HEX BOLTS (46), 3/8" NUTS (FINE THREAD) (46), 3/8" FLAT WASHERS (48), 3/8" LOCK WASHERS (49) TO ATTACH EXTENDED KEEPER PLATE AS SHOWN. TIGHTEN SECURELY.
- LOCATE AXLE HARDWARE AS SHOWN FOR FINAL POSITION. (SEE DIAGRAM 16)

UP TO"	"A" DIMENSION
10' / 3.04m	9-1/4" / 234.9mm
12' / 3.65m	10" / 254mm
14' / 4.26m	10-1/2" / 266.7mm
16' / 4.87m	11-1/8" / 282.5mm
18' / 5.48m	11-3/4" / 298.4mm
20' / 6.09m	12-1/4" / 311.1mm

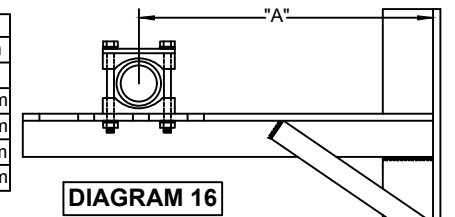

NOTE:

- DIMENSIONS ARE APPROXIMATE POSITION FOR OPTIMAL PERFORMANCE. ADJUST AS NEEDED.
- TO SPIN DOOR FOR PRETENSIONING SPRINGS, MIGHT REQUIRE MOVING THE DOOR AWAY FROM THE WALL TO ALLOW BOTTOM BAR TO PASS. IF SO, LOOSEN HARDWARE ONE SIDE AT A TIME & SLIDE DOOR AXLE TOWARD WALL TO ITS BEST POSITION. BE CAREFUL DOOR WILL BE UNDER TENSION.

STEP #6 - PRE-TENSION SPRINGS

- INSTALL CHAIN CLIP (79) APPROXIMATELY 4'-0" ABOVE FLOOR ON CHAIN OPERATED DOORS. INSTALLATION MUST BE SECURE.
- APPLY PRE-TENSION TO THE SPRINGS BY ROTATING THE DOOR TWO (2) TURNS IN A FORWARD DIRECTION (SEE DIAGRAM 17). THE BOTTOM ANGLE IS TO BE IN A 6 O'CLOCK POSITION.

DIAGRAM 17

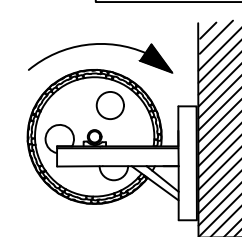
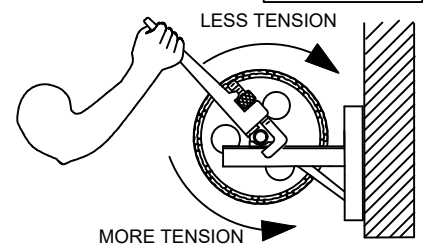

DIAGRAM 18



- IF YOU'RE UNABLE TO ROTATE DOOR TO PRE-TENSION, USE A PIPE WRENCH TO ROTATE AXLE IN OPPOSITE DIRECTION. WITH ONE PERSON ON EACH SIDE OF DOOR, EACH PERSON SHOULD FIRMLY PLACE A LARGE PIPE WRENCH ON THE DOOR AXLE (SEE DIAGRAM 18). PULL DOWN TO APPLY TENSION INCREMENTALLY UNTIL YOU ACHIEVE TWO FULL ROTATIONS OF THE DOOR AXLE. THEN TIGHTEN THE AXLE HARDWARE.
- REPEAT STEP "C" IF ADJUSTMENT IS NECESSARY.

STEP #7 - REMOVE PLASTIC WRAPPING

- TAKE HOLD OF THE DOOR BY THE BOTTOM ANGLE AND REMOVE THE OUTER WRAPPING AND TAPE THAT HOLDS THE DOOR IN A ROLL.
- CAREFULLY LOWER THE DOOR DOWN AND SECURE THE DOOR APPROXIMATELY 4' FROM THE FLOOR TO PREVENT UPWARD TRAVEL USING CLAMPS OR HOOK HAND CHAIN IF A CHAIN HOIST DOOR.

STEP #8 - INSTALL DOOR STOPS (LIFT CLIPS) AND SLIDE BOLT LOCKS

- INSTALL THE DOOR STOPS (53) AND THE SLIDE BOLT LOCKS (54) USING 1/4"x1-1/4" CARRIAGE BOLT (55), 1/4" FLAT WASHER (58), 5/16" NUT (57), AND 1/4" SELF LOCKING NUT (56) PER SIDE.
- ELECTRONICALLY OPERATED DOORS STILL REQUIRE DOOR STOPS (LIFT CLIPS) TO BE INSTALLED. WINDLOCK "CERTIFIED" DOORS REQUIRE SLIDE BOLT LOCKS TO BE INSTALLED FOR PROPER WINDLOAD PROTECTION. ELECTRICAL INTERLOCKS ARE HIGHLY RECOMMENDED

NOTE:

- WHEN INSTALLING SLIDE BOLT LOCKS THE THREADS FROM THE CARRIAGE HEAD BOLTS PROTRUDING FROM THE SELF LOCKING NUT SHOULD BE REMOVED TO A FLUSH POSITION WITH SELF LOCKING NUT TO PREVENT DOOR FROM HANGING UP ON THE HEAD STOPS. CLAMP A PAIR OF VICE GRIPS ON TO THE THREAD AND BREAK OFF, IF NECESSARY.

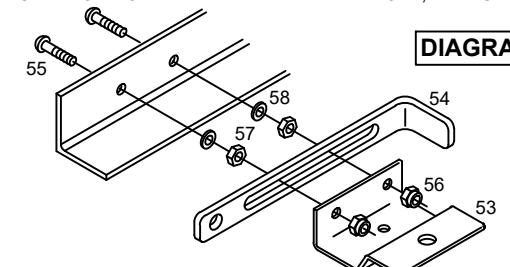

DIAGRAM 19